

SMF Series

ROHS

3.3 To 190V 200W

Surface Mount Transient Voltage Suppressors (TVS)

Description

The SMF series is designed specifically to protect sensitive electronic equipment from voltage transients induced by lightning and other transient voltage events

Features

- ◆ Compatible with industrial standard package SOD-123
- ◆ For surface mounted applications in order to optimize board space
- ◆ Low leakage
- ◆ Uni and Bidirectional unit
- ◆ Glass passivated junction
- ◆ Low inductance
- ◆ Excellent clamping capability
- ◆ 200W Peak power capability at 10/1000us waveform Repetition rate (duty cycle):0.01%
- ◆ Fast response time: typically less than 1.0ps from 0 Volts to VBR min
- ◆ Typical IR less than 1uA above 12V
- ◆ High Temperature soldering: 260°C/40 seconds at terminals
- ◆ Typical maximum temperature coefficient $\Delta V_{BR} = 0.1\% \times V_{BR}@25^{\circ}\text{C} \times \Delta T$
- ◆ Plastic package has Underwriters Laboratory Flammability 94V-0
- ◆ Matte tin lead-free Plated
- ◆ Halogen free and RoHS compliant
- ◆ Typical failure mode is short from over-specified voltage or current
- ◆ Whisker test is conducted based on JEDEC JESD201A per its table 4a and 4c
- ◆ IEC-61000-4-2 ESD 30kV(Air), 30kV (Contact)
- ◆ ESD protection of data lines in accordance with IEC 61000-4-2
- ◆ EFT protection of data lines in accordance with IEC 61000-4-4

Applications

TVS devices are ideal for the protection of I/O interfaces, V_{CC} bus and other vulnerable circuits used in Telecom, Computer, Industrial and Consumer electronic applications.

Maximum Ratings(TA=25°C unless otherwise noted)

Parameter	Symbol	Value	Unit
Peak Pulse Power Dissipation with a 10/1000us waveform (Fig.1)(Note 1), (Note 2)	PPPM	200	W
Peak Pulse Power Dissipation with a 8/20us waveform (Fig.1)(Note 1),(Note 2)	PPPM	1000	W
Peak Pulse Current with a 10/1000us waveform.(Note1, Fig.3)	IPP	See Next Table	A
Power Dissipation on Infinite Heat Sink at TL=75°C	PM(AV)	0.4	W
Peak Forward Surge Current, 8.3ms Single Half Sine Wave (Note 3)	IFSM	20	A
Maximum Instantaneous Forward Voltage at 25A for Unidirectional Only (Note 4)	VF	3.5	V
Junction and Storage Temperature Range	TJ , TSTG	-55 to +150	°C
Operating Temperature Range	TOP	-40 to +150	°C

- Notes:**
1. Non-repetitive current pulse, per Fig. 3 and derated above TA = 25°C per Fig. 2.
 2. Mounted on 5.0mm x 5.0mm (0.03mm thick) Copper Pads to each terminal.
 3. 8.3ms single half sine-wave, or equivalent square wave, Duty cycle = 4 pulses per minutes maximum.
 4. VF < 3.5V for VBR < 200V and VF < 6.5V for VBR > 201V.



www.unsemi.com.tw

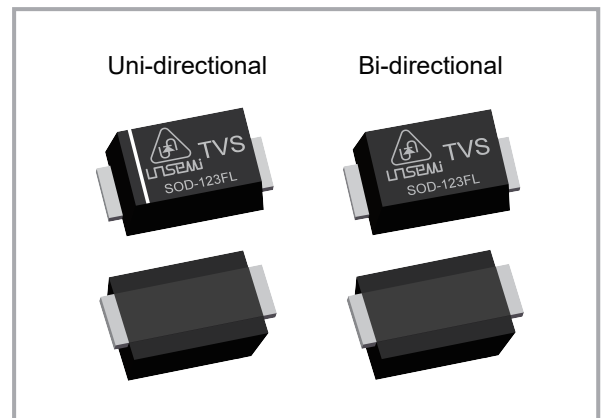

Functional Diagram

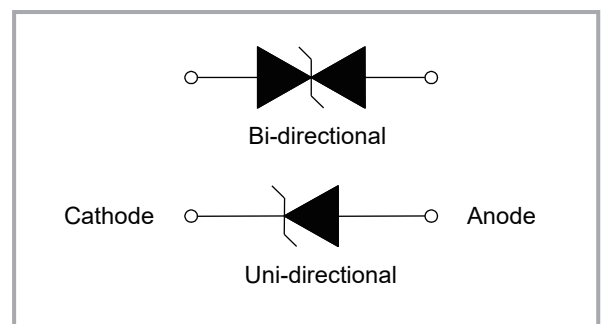

Electrical Characteristics (TA=25°C unless otherwise noted) (Continue)

Part Number		Marking		Reverse Stand-Off Voltage VRWM (V)	Breakdown Voltage VBR (V) @IT		Test Current IT (mA)	Maximum Clamping Voltage Vc @IPP (V)	Maximum Peak Pulse Current IPP (A)	Maximum Reverse Leakage IR @VRWM (uA)
Uni	Bi	Uni	Bi		MIN	MAX				
SMF3.3A	-	FD	-	3.3	5.20	6.00	10	8.0	25.00	400
SMF5.0A	SMF5.0CA	FE	KE	5.0	6.40	7.00	10	9.2	21.74	400
SMF6.0A	SMF6.0CA	FG	KG	6.0	6.67	7.37	10	10.3	19.42	400
SMF6.5A	SMF6.5CA	FK	KK	6.5	7.22	7.98	10	11.2	17.86	250
SMF7.0A	SMF7.0CA	FM	KM	7.0	7.78	8.60	10	12.0	16.67	100
SMF7.5A	SMF7.5CA	FP	KP	7.5	8.33	9.21	1	12.9	15.50	50
SMF8.0A	SMF8.0CA	FR	KR	8.0	8.89	9.83	1	13.6	14.71	25
SMF8.5A	SMF8.5CA	FT	KT	8.5	9.44	10.40	1	14.4	13.89	10
SMF9.0A	SMF9.0CA	FV	KV	9.0	10.00	11.10	1	15.4	12.99	5
SMF10A	SMF10CA	FX	KX	10.0	11.10	12.30	1	17.0	11.76	2.5
SMF11A	SMF11CA	FZ	KZ	11.0	12.20	13.50	1	18.2	10.99	2.5
SMF12A	SMF12CA	HE	LE	12.0	13.30	14.70	1	19.9	10.05	2.5
SMF13A	SMF13CA	HG	LG	13.0	14.40	15.90	1	21.5	9.30	1
SMF14A	SMF14CA	HK	LK	14.0	15.60	17.20	1	23.2	8.62	1
SMF15A	SMF15CA	HM	LM	15.0	16.70	18.50	1	24.4	8.20	1
SMF16A	SMF16CA	HP	LP	16.0	17.80	19.70	1	26.0	7.69	1
SMF17A	SMF17CA	HR	LR	17.0	18.90	20.90	1	27.6	7.25	1
SMF18A	SMF18CA	HT	LT	18.0	20.00	22.10	1	29.2	6.85	1
SMF19A	SMF19CA	HB	LB	19.0	21.10	23.30	1	30.6	6.54	1
SMF20A	SMF20CA	HV	LV	20.0	22.20	24.50	1	32.4	6.17	1
SMF22A	SMF22CA	HX	LX	22.0	24.40	26.90	1	35.5	5.63	1
SMF24A	SMF24CA	HZ	LZ	24.0	26.70	29.50	1	38.9	5.14	1
SMF26A	SMF26CA	JE	ME	26.0	28.90	31.90	1	42.1	4.75	1
SMF28A	SMF28CA	JG	MG	28.0	31.10	34.40	1	45.4	4.41	1
SMF30A	SMF30CA	JK	MK	30.0	33.30	36.80	1	48.4	4.13	1
SMF33A	SMF33CA	JM	MM	33.0	36.70	40.60	1	53.3	3.75	1
SMF36A	SMF36CA	JP	MP	36.0	40.00	44.20	1	58.1	3.44	1
SMF40A	SMF40CA	JR	MR	40.0	44.40	49.10	1	64.5	3.10	1
SMF43A	SMF43CA	JT	MT	43.0	47.80	52.80	1	69.4	2.88	1
SMF45A	SMF45CA	JV	MV	45.0	50.00	55.30	1	72.7	2.75	1
SMF48A	SMF48CA	JX	MX	48.0	53.30	58.90	1	77.4	2.58	1
SMF51A	SMF51CA	JZ	MZ	51.0	56.70	62.70	1	82.4	2.43	1
SMF54A	SMF54CA	XE	NE	54.0	60.00	66.30	1	87.1	2.30	1
SMF58A	SMF58CA	XG	NG	58.0	64.40	71.20	1	93.6	2.14	1
SMF60A	SMF60CA	XK	NK	60.0	66.70	73.70	1	96.8	2.07	1
SMF64A	SMF64CA	XM	NM	64.0	71.10	78.60	1	103.0	1.94	1
SMF70A	SMF70CA	XP	NP	70.0	77.80	86.00	1	113.0	1.77	1
SMF75A	SMF75CA	XR	NR	75.0	83.30	92.10	1	121.0	1.65	1
SMF78A	SMF78CA	XT	NT	78.0	86.70	95.80	1	126.0	1.59	1
SMF80A	SMF80CA	XB	NB	80.0	88.80	97.60	1	129.0	1.55	1
SMF85A	SMF85CA	XV	NV	85.0	94.40	104.00	1	137.0	1.46	1
SMF90A	SMF90CA	XX	NX	90.0	100.00	111.00	1	146.0	1.37	1
SMF100A	SMF100CA	XZ	NZ	100.0	111.00	123.00	1	162.0	1.23	1
SMF110A	SMF110CA	TE	PE	110.0	122.00	135.00	1	177.0	1.13	1
SMF120A	SMF120CA	TG	PG	120.0	133.00	147.00	1	193.0	1.04	1
SMF130A	SMF130CA	TK	PK	130.0	144.00	159.00	1	209.0	0.96	1
SMF140A	SMF140CA	TB	PB	140.0	155.00	171.00	1	224.0	0.89	1
SMF150A	SMF150CA	TM	PM	150.0	167.00	185.00	1	243.0	0.82	1
SMF160A	SMF160CA	TP	PP	160.0	178.00	197.00	1	259.0	0.77	1
SMF170A	SMF170CA	TR	PR	170.0	189.00	209.00	1	275.0	0.73	1
SMF180A	SMF180CA	TT	PT	180.0	200.00	220.00	1	292.0	0.69	1
SMF190A	SMF190CA	TV	PV	190.0	211.00	232.00	1	308.0	0.65	1

- Note: 1. Suffix 'A' denotes 5% tolerance device. Without 'A' denotes 10% tolerance device
 2. Add suffix 'C' or 'CA' after part number to specify Bi-directional devices
 3. For Bi-Directional devices having VR of 10 volts and under, the IR limit is double

Ratings and Characteristic Curves (TA=25°C unless otherwise noted)

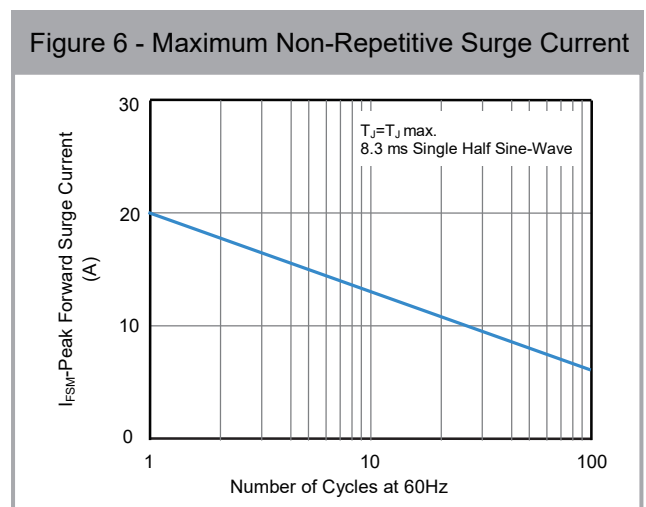
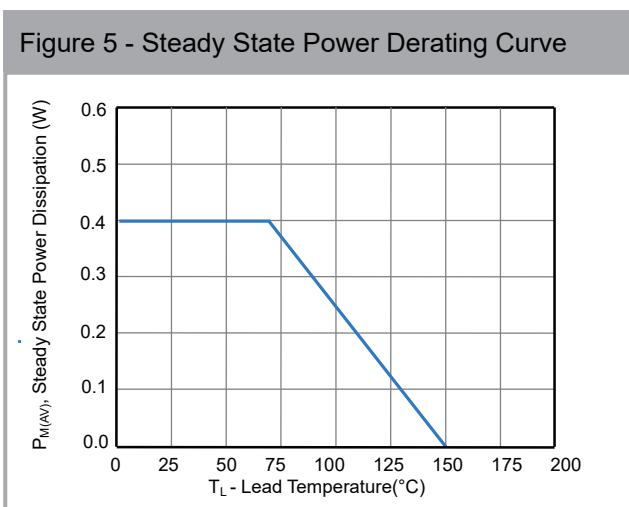
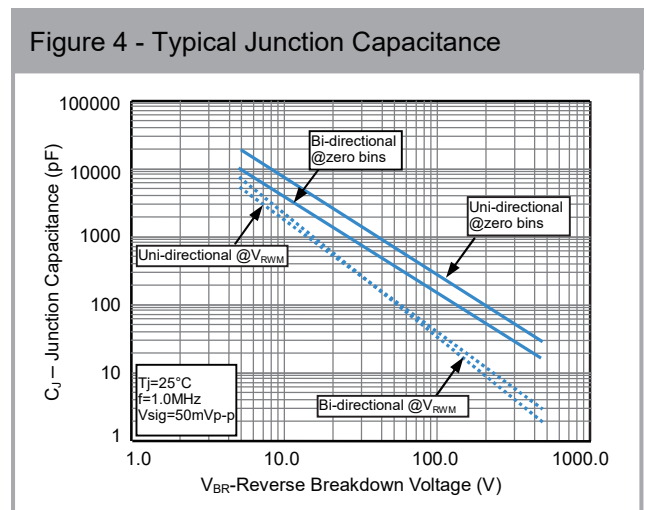
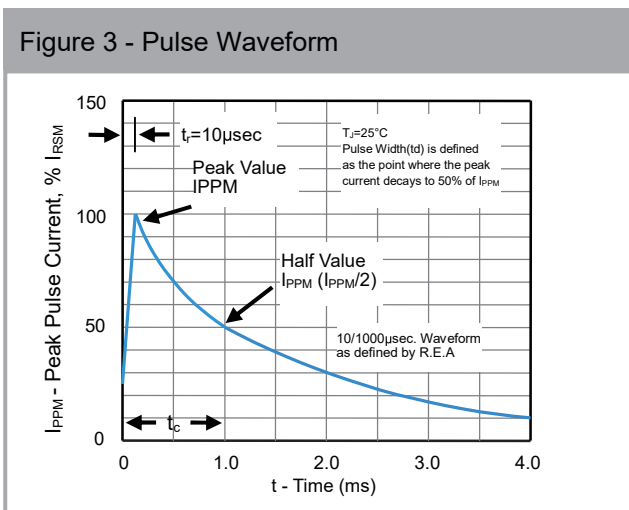
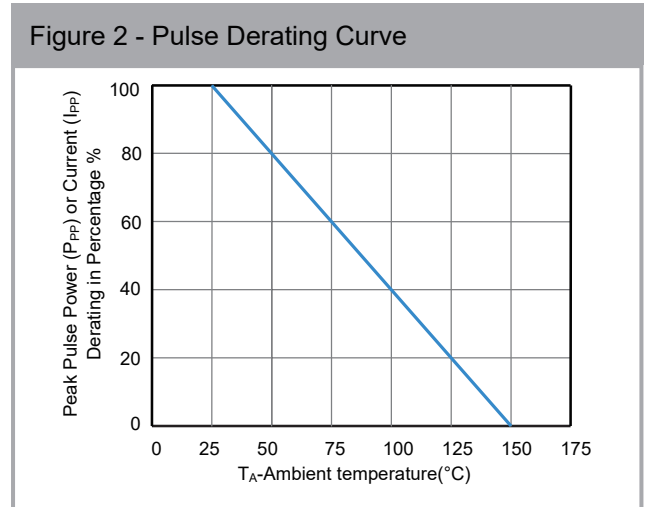
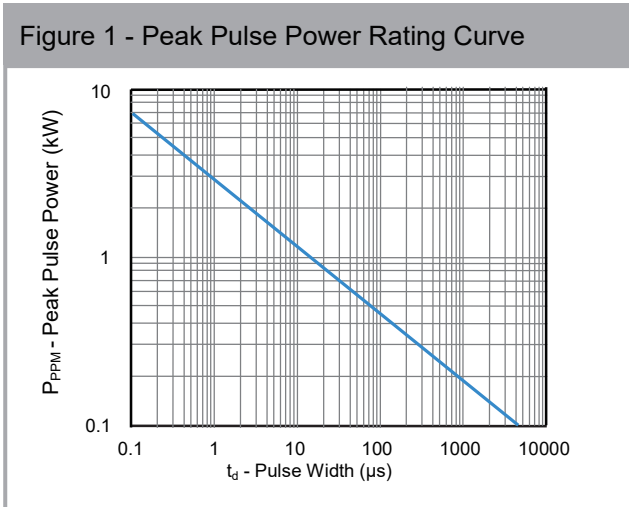

I-V Curve Characteristics

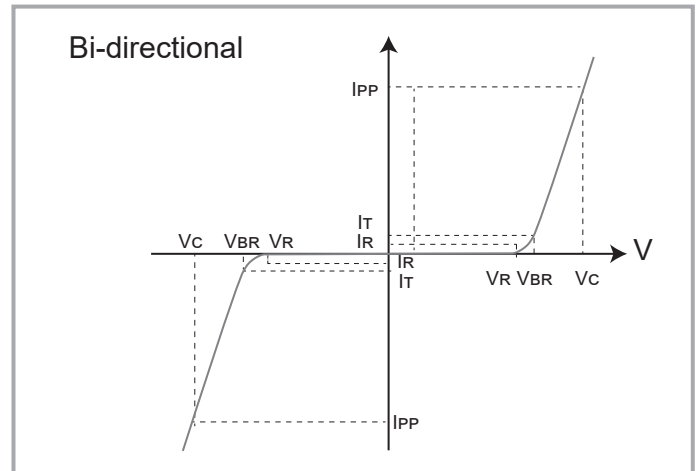
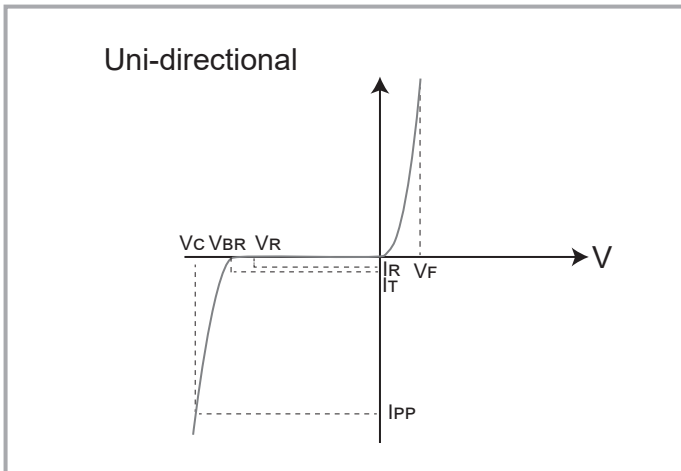

Physical Specifications

Case	SOD-123 Molded Plasticover glass passivated junction
Polarity	Color band denotes cathode except Bipolar
Terminal	Matte Tin-plated leads, Solderable per JESD22-B102D

Environmental Specifications

Temperature Cycle	JESD22-A104
Pressure Cooker	JESD22-A102
High Temp. Storage	JESD22-A103
HTRB	JESD22-A108
Thermal Shock	JESD22-A106

Soldering Parameters

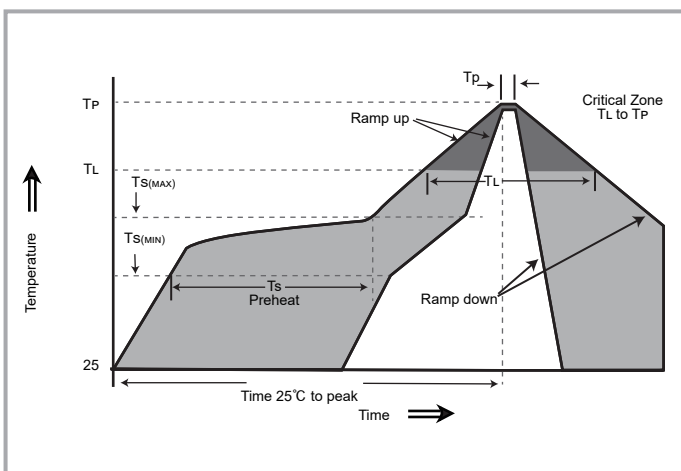

Reflow Condition		Lead-free assembly
Pre Heat	- Temperature Min (Ts(min))	150°C
	- Temperature Max (Ts(max))	200°C
	- Time (min to max) (Ts)	60 -180 Seconds
Average ramp up rate (Liquidus Temp TL) to peak		3°C/second max
Ts(max) to TL - Ramp-up Rate		3°C/second max
Reflow	- Temperature (TL) (Liquidus)	217°C
	- Time (min to max) (Ts)	60 -150 Seconds
Peak Temperature (TP)		260 +0/-5°C
Time within 5°C of actual peak Temperature (TP)		20 - 40 Seconds
Ramp-down Rate		6°C/second max
Time 25°C to peak Temperature (TP)		8 minutes Max
Do not exceed		280°C

Dimensions

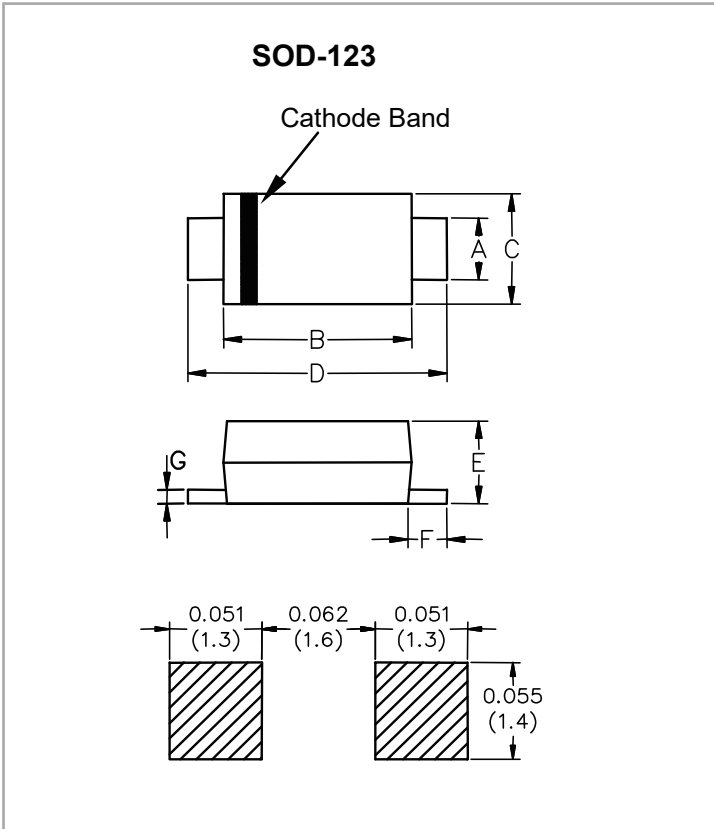

Dimensions	Inches		Millimeters	
	Min	Max	Min	Max
A	0.031	0.044	0.77	1.09
B	0.100	0.112	2.51	2.81
C	0.055	0.071	1.38	1.85
D	0.140	0.152	3.51	3.82
E	0.037	0.053	0.93	1.33
F	0.01	-	0.25	-
G	-	0.008	-	0.20

Part Numbering

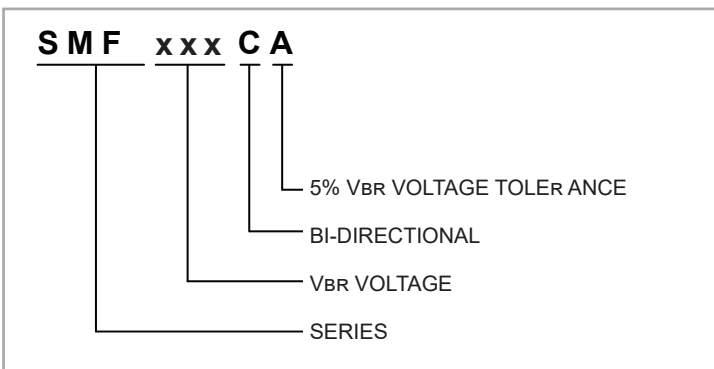

Packaging

Part Number	Component Package	Quantity	Packaging Option	Packaging Specification
SMFXXXXX	SOD-123	3,000	Tape & Reel -8mm/7"tape	EIA STD RS-481

Packaging Dimensions Unit: Inches (Millimeters)

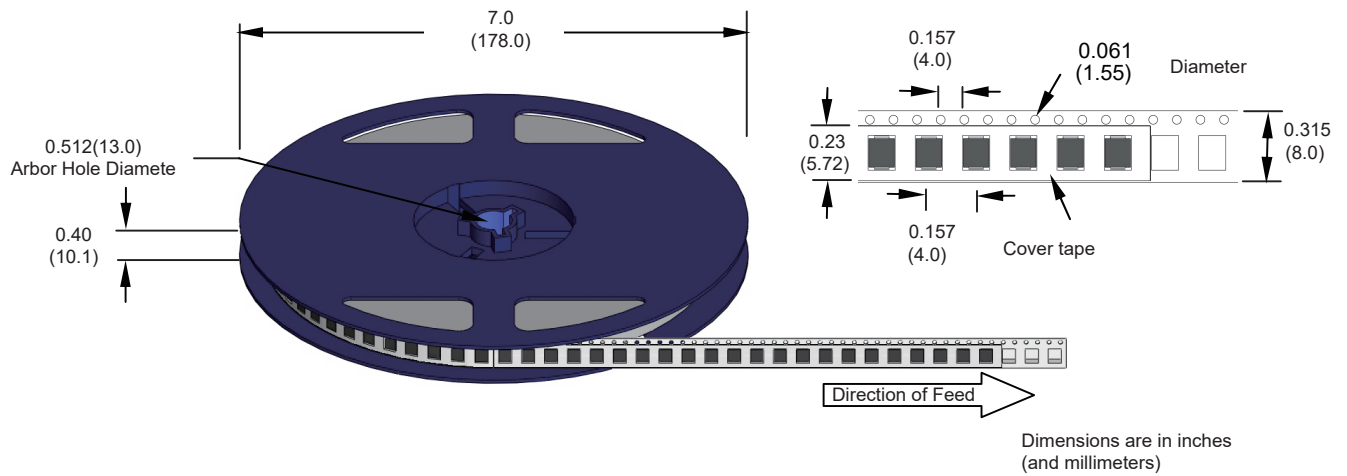

Disclaimer

UNSEMI RESERVES THE RIGHT TO MAKE CHANGE ON OUR PRODUCTS , PRODUCTS SPECIFICATION AND DATA WITHOUT NOTICE TO IMPROVE RELIABILITY, FUNCTION OR DESIGN OR OTHERWISE.

UN SEMICONDUCTOR LIMITED its affiliates, agents, and employees, and all persons acting on its or their behalf (collectively, "UNSEMI") does not give any representations or warranties for any errors, inaccuracies or incompleteness contained in any datasheet or in any other disclosure relating to any product.

In no event shall UNSEMI be liable for any indirect, incidental, punitive, special or consequential damages (including any and all implied warranties, warranties of fitness for particular purpose, non-infringement and merchantability.) whether or not such damages are based on tort (including negligence), warranty, breach of contract or any other legal theory.

Statements regarding the suitability of products for certain types of applications are based on UNSEMI knowledge of typical requirements that are often placed on UNSEMI products in generic applications. Such statements are not binding, statements about the suitability of products for a particular application. It is the customer's responsibility to validate that a particular product with the properties described in the product specification is suitable for use in a particular application. Parameters provided in datasheets or specifications may vary in different applications and performance may vary over time. All operating parameters, including typical parameters, must be validated for each customer application by the customer's technical experts. Product specifications do not expand or otherwise modify UNSEMI's terms and conditions of purchase, including but not limited to the warranty expressed therein.

Unless otherwise agreed in writing, UNSEMI product is not designed, authorized or warranted to be suitable for use in medical life-saving, or life-sustaining application , nor in applications where failure or malfunction of a UNSEMI product can reasonably be expected to result in personal injury, death or severe property or environmental damage. UNSEMI and its suppliers accept no liability for inclusion or use of UNSEMI products in such equipment or applications and therefore such inclusion and/or use is at the customer's own risk.

All referenced brands, product names, service names and trademarks are the property of their respective owners.