

S8550

Plastic-Encapsulate Transistor(PNP)

ROHS

Features

- ◆ Complimentary to S8050



www.unsemi.com.tw

Mechanical Data

- ◆ JEDEC SOT-23 Package
- ◆ Molding Compound Flammability Rating : UL 94V-O
- ◆ Quantity Per Reel : 3,000pcs
- ◆ Marking : 2TY

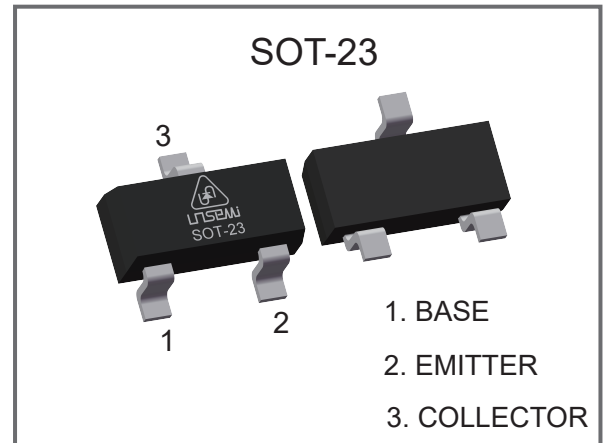

Maximum Ratings (TA=25°C Unless Otherwise Noted)

Parameter	Symbol	Value	Units
Collector-Base Voltage	V _{CB0}	-40	V
Collector-Emitter Voltage	V _{CEO}	-25	V
Emitter-Base Voltage	V _{EB0}	-5.0	V
Collector Current	I _C	-0.5	A
Collector Power Dissipation	P _C	0.3	W
Junction Temperature Range	T _J	-55~+150	°C
Storage Temperature Range	T _{stg}	-55~+150	°C

Electrical Characteristics(TA=25°C Unless Otherwise Specified)

Parameter	Symbol	Test Conditions	Min.	Typ.	Max.	Units
Collector-Base Breakdown Voltage	$V_{(BR)CBO}$	$I_C = -100\mu A, I_E = 0$	-40			V
Collector-Emitter Breakdown Voltage	$V_{(BR)CEO}$	$I_C = -1mA, I_B = 0$	-25			V
Emitter-Base Breakdown Voltage	$V_{(BR)EBO}$	$I_E = -100\mu A, I_C = 0$	-5.0			V
Collector Cut-Off Current	I_{CBO}	$V_{CB} = -40V, I_E = 0$			-0.1	μA
Collector Cut-Off Current	I_{CEO}	$V_{CE} = -20V, I_B = 0$			-0.1	μA
Emitter Cut-Off Current	I_{EBO}	$V_{EB} = -3V, I_C = 0$			-0.1	μA
DC Current Gain	$h_{FE(1)}$	$V_{CE} = -1V, I_C = -50mA$	200		350	
	$h_{FE(2)}$	$V_{CE} = -1V, I_C = -500mA$	50			
Collector-Emitter Saturation Voltage	$V_{CE(sat)}$	$I_C = -500mA, I_B = -50mA$			-0.6	V
Base-Emitter Saturation Voltage	$V_{BE(sat)}$	$I_C = -500mA, I_B = -50mA$			-1.2	V
Transition Frequency	f_T	$V_{CE} = -6V, I_C = -20mA, f = 30MHz$	150			MHz

Classification of hFE

Parameter	Unit
hFE	200-350

Electrical Characteristics Curves

Fig. 1 Static Characteristic

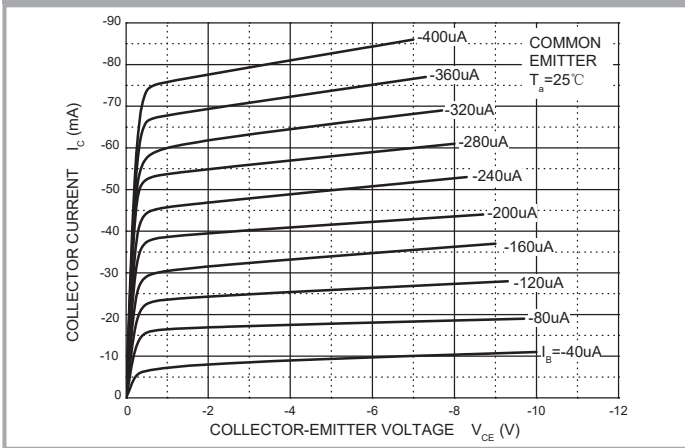

Fig. 2 hFE — Ic

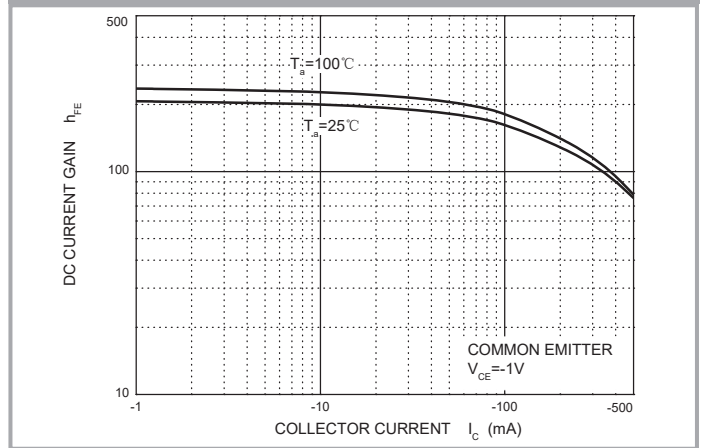

Fig. 3 V_{CE(sat)} — Ic

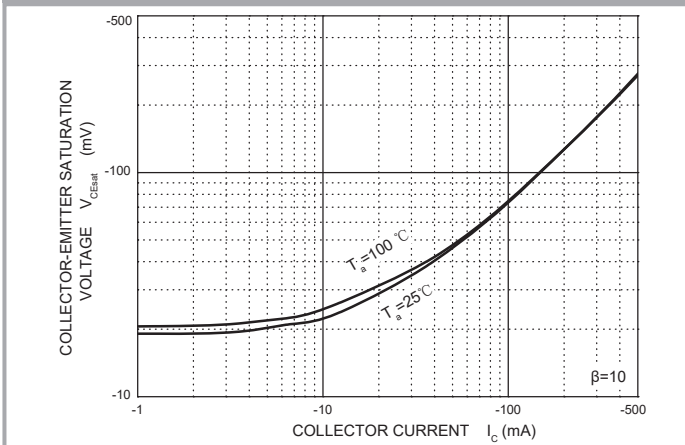

Fig. 4 V_{BE(sat)} — Ic

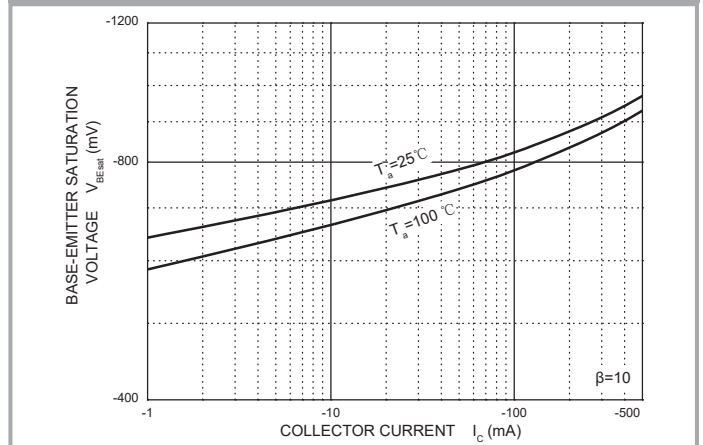

Fig. 5 Ic — VBE

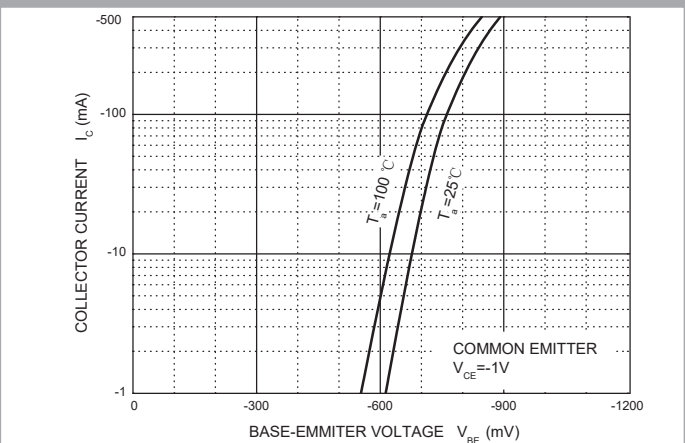
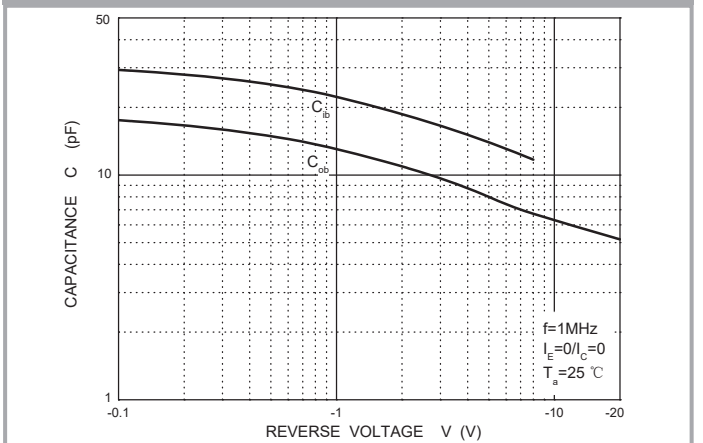

Fig. 6 Cob/ Cib — VCB/ VEB



Electrical Characteristics Curves

Fig. 7 f_T — I_C

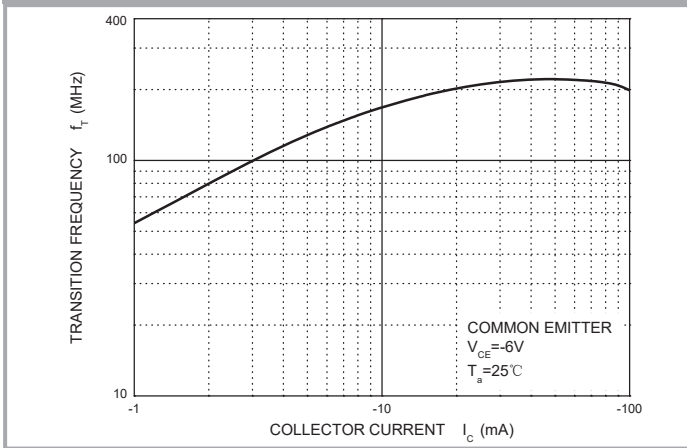
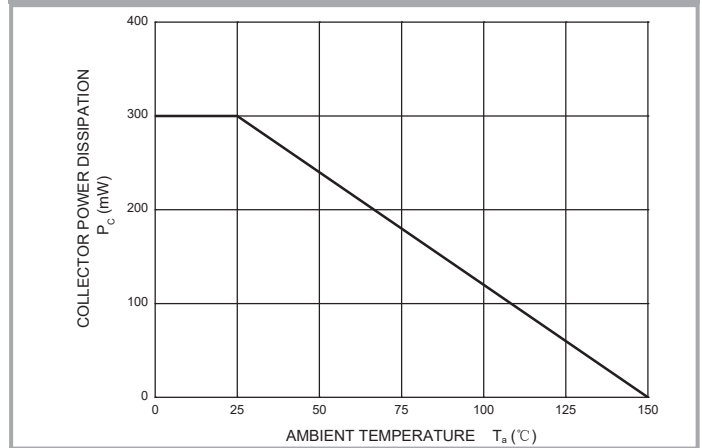
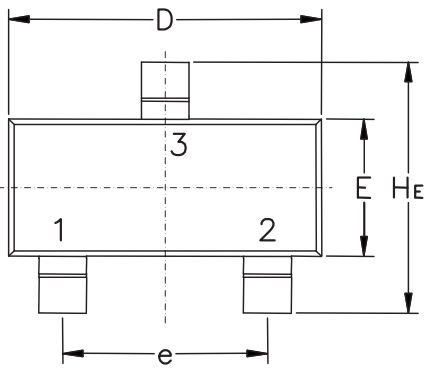

Fig. 8 P_C — T_a



SOT-23 Package Outline & Dimensions (Units: mm / in)



Symbol	Millimeters			Inches		
	Min.	Nom.	Max.	Min.	Nom.	Max.
A	0.89	1.00	1.11	0.035	0.040	0.044
A1	0.01	0.06	0.10	0.001	0.002	0.004
b	0.37	0.44	0.50	0.015	0.018	0.020
C	0.09	0.13	0.18	0.003	0.005	0.007
D	2.80	2.90	3.04	0.110	0.114	0.120
E	1.20	1.30	1.40	0.047	0.051	0.055
e	1.78	1.90	2.04	0.070	0.075	0.081
L	0.35	0.54	0.69	0.014	0.021	0.029
HE	2.10	2.40	2.64	0.083	0.094	0.104

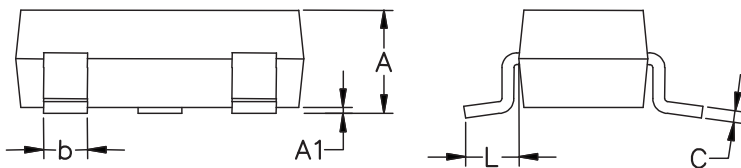

Soldering Footprint

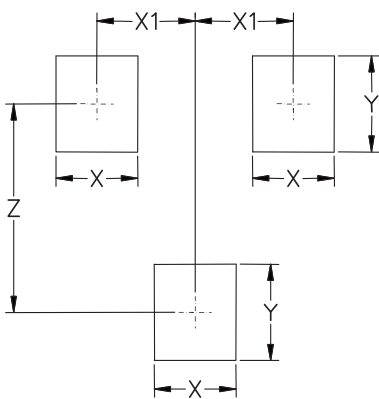

Symbol	Millimeters	Inches
X	0.80	0.031
X1	0.96	0.037
Y	0.90	0.035
Z	2.00	0.079

Disclaimer

UNSEMI RESERVES THE RIGHT TO MAKE CHANGE ON OUR PRODUCTS , PRODUCTS SPECIFICATION AND DATA WITHOUT NOTICE TO IMPROVE RELIABILITY, FUNCTION OR DESIGN OR OTHERWISE.

UN SEMICONDUCTOR LIMITED its affiliates, agents, and employees, and all persons acting on its or their behalf (collectively, "UNSEMI") does not give any representations or warranties for any errors, inaccuracies or incompleteness contained in any datasheet or in any other disclosure relating to any product.

In no event shall UNSEMI be liable for any indirect, incidental, punitive, special or consequential damages (including any and all implied warranties, warranties of fitness for particular purpose, non-infringement and merchantability.) whether or not such damages are based on tort (including negligence), warranty, breach of contract or any other legal theory.

Statements regarding the suitability of products for certain types of applications are based on UNSEMI knowledge of typical requirements that are often placed on UNSEMI products in generic applications. Such statements are not binding, statements about the suitability of products for a particular application. It is the customer's responsibility to validate that a particular product with the properties described in the product specification is suitable for use in a particular application. Parameters provided in datasheets or specifications may vary in different applications and performance may vary over time. All operating parameters, including typical parameters, must be validated for each customer application by the customer's technical experts. Product specifications do not expand or otherwise modify UNSEMI's terms and conditions of purchase, including but not limited to the warranty expressed therein.

Unless otherwise agreed in writing, UNSEMI product is not designed, authorized or warranted to be suitable for use in medical life-saving, or life-sustaining application , nor in applications where failure or malfunction of a UNSEMI product can reasonably be expected to result in personal injury, death or severe property or environmental damage. UNSEMI and its suppliers accept no liability for inclusion or use of UNSEMI products in such equipment or applications and therefore such inclusion and/or use is at the customer's own risk.

All referenced brands, product names, service names and trademarks are the property of their respective owners.